

TOSHIBA

Leading Innovation >>>

CMOS COLOR CAMERA

INSTRUCTION MANUAL

IK-HR2D

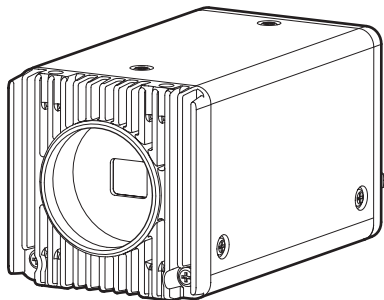

For Customer Use

Enter the Serial # (which is located on the bottom of the cabinet) below. Retain this information for future reference.

Model # IK-HR2D

Serial # _____

FCC NOTICE

This equipment has been tested and found to comply with the limits for a Class A digital device, pursuant to Part 15 of the FCC Rules. These limits are designed to provide reasonable protection against harmful interference when the equipment is operated in a commercial environment. This equipment generates, uses, and can radiate radio frequency energy and, if not installed and used in accordance with the instruction manual, may cause harmful interference to radio communications. Operation of this equipment in a residential area is likely to cause harmful interference in which case the user will be required to correct the interference at his own expense.

USER-INSTALLER CAUTION: Your authority to operate this FCC verified equipment could be voided if you make changes or modifications not expressly approved by the party responsible for compliance to Part 15 of the FCC Rules.

This Class A digital apparatus complies with Canadian ICES-003.

Cet appareil numérique de la classe A est conforme à la norme NMB-003 du Canada.

Following information is only for EU-member states:

In residential areas this product may cause radio interference, therefore this product must not be used in residential areas.

Following information is only for EU-member states:

The use of the symbol indicates that this product may not be treated as household waste. By ensuring this product is disposed of correctly, you will help prevent potential negative consequences for the environment and human health, which could otherwise be caused by inappropriate waste handling of this product. For more detailed information about the take-back and recycling of this product, please contact your supplier where you purchased the product or consult.



SAFETY PRECAUTIONS

Safety icons

This manual contains safety instructions that must be observed in order to avoid potential hazards that could result in personal injuries, damage to your equipment, or loss of data. These safety cautions have been classified according to the seriousness of the risk, and the icons highlight these instructions as follows:

▲ WARNING Indicates a potentially hazardous situation which, if not avoided, could result in death or serious injury.

▲ CAUTION Indicates a potentially hazardous situation which, if not avoided, may result in minor or moderate injury.

CAUTION Indicates a potentially hazardous situation which, if not avoided, may result in property damage.

▲ WARNING **Stop operation immediately if any abnormality or defect occurs.**
Use during an abnormal condition; such as emitting smoke, burning odors, damage from dropping, invasion of foreign objects, etc. may result in fire and/or electrical shock. Immediately disconnect the power source and contact your dealer.

▲ WARNING **Avoid installing in a shower room or a bathroom.**
This may result in fire and/or electrical shock.

▲ WARNING **Do not operate in places where the product may get wet.**
This may result in fire and/or electrical shock.

▲ WARNING **Do not repair, disassemble and/or modify by yourself.**
This may result in fire and/or electrical shock. Always be sure to contact your dealer for internal repair, check and cleaning of the product.

▲ WARNING **Use the specified power supply.**
Otherwise, fire or electrical shock may occur.

▲ WARNING **Do not place anything on top of the unit.**
Foreign materials, such as metals or liquids, getting into the product may result in fire and/or electrical shock.

▲ WARNING **Do not put the product on an unstable, slanted or vibrating surface.**
The product dropping or falling may result in serious injury.

▲ WARNING **Do not touch the product or any connection cables during a thunderstorm.**
This may result in electrical shock.

CAUTION**Note the following instructions when installing.**

- Do not cover the product with any material.
- Do not place the product on any inflammable material such as a carpet or blanket.
- Do not place the product in a confined space, as this may cause heat to build up inside the product.

Failure to follow the above cautions may result in fire.

CAUTION**Do not place the product in direct sunshine and/or high temperature.**

Temperature build up inside the product may result in fire.

▲ CAUTION**Avoid placing in humid, smoky, or dusty places.**

This may result in fire and/or electrical shock.

▲ CAUTION**Do not point the lens directly at the sun and/or intensive light such as direct sunlight, etc.**

Focusing of the light may result in eye injury and/or fire.

CAUTION**Ask your dealer to perform a periodical check and internal cleaning (approx. once every five years).**

Dust inside the product may result in fire. For service and cleaning cost, please consult your dealer.

Disclaimer

We disclaim any responsibility and shall be held harmless for any damages or losses incurred by the user in any of the following cases:

1. Fire, earthquake or any other act of God; acts by third parties; misuse by the user, whether intentional or accidental; use under extreme operating conditions.
2. Malfunction or non-function resulting in indirect, additional or consequential damages, including but not limited to loss of expected income and suspension of business activities.
3. Incorrect use not in compliance with instructions in this instruction manual.
4. Malfunctions resulting from misconnection to other equipment.
5. Repairs or modifications made by the user or caused to be made by the user and carried out by an unauthorized third party.
6. Notwithstanding the foregoing, Toshiba's liabilities shall not, in any circumstances, exceed the purchase price of the product.

Copyright and Right of Portrait

There may be a conflict with the Copyright Law and other laws when a customer uses, displays, distributes, or exhibits an image picked up by the camera without permission from the copyright holder. Please also note that transfer of an image or file covered by copyright is restricted to use within the scope permitted by the Copyright Law.

Protection of Personal Information

Images taken by the camera that reveal the likeness of an individual person may be considered personal information. To disclose, exhibit or transmit those images over the internet or otherwise, consent of the person may be required.

Limitation of Usage

The product is not designed for any “critical applications.” “Critical applications” means life support systems, exhaust or smoke extraction applications, medical applications, commercial aviation, mass transit applications, military applications, homeland security applications, nuclear facilities or systems or any other applications where product failure could lead to injury to persons or loss of life or catastrophic property damage. Accordingly, [Toshiba/TAIS] disclaims any and all liability arising out of the use of the product in any critical applications.

Trademarks and Registered Trademarks

Microsoft, Windows, Windows Vista, and DirectX are registered trademarks of Microsoft Corporation. Intel, Pentium is a registered trademark of Intel Corporation.

TABLE OF CONTENTS

SAFETY PRECAUTION	2
Disclaimer	3
Copyright and Right of Portrait	3
Protection of Personal Information	3
Limitation of Usage	4
Trademarks and Registered Trademarks	4
1. CAUTIONS ON USE AND INSTALLATION	6
2. COMPONENTS	6
3. NAMES AND FUNCTIONS.....	7
4. CONNECTION.....	8
4.1 Standard Connection	8
4.2 Cautions on Connection.....	8
4.3 Connection on Rear Panel.....	9
5. OPERATION.....	10
5.1 White Balance.....	10
5.2 Gain	12
5.3 Switching video signal output	12
5.4 Display video with USB	13
6. ITEMS CONTROLLED BY THE ON SCREEN DISPLAY	14
7. MODE SETTING BY THE ON SCREEN DISPLAY	15
7.1 Using the Menus	15
7.2 Scene File	16
7.3 Menus	16
(1) SHUTTER (Electronic shutter)	16
(1.1) Changing the setting in AUTO mode.....	17
(1.2) Changing the setting in MANUAL mode.....	18
(1.3) Changing the setting in SS (Synchro Scan) mode	19
(2) GAIN (Video gain)	20
(2.1) Changing gain in MANUAL mode.....	20

(3) WHT BAL (White Balance).....	20
(3.1) Changing the setting in AWB (Automatic White Balance) mode	20
(3.2) Changing the setting in ATW (Automatic Tracking White balance) mode	22
(3.3) Changing gain in MANUAL mode	23
(4) PROCESS	24
(4.1) Changing gamma correction ON/OFF	24
(4.2) Changing gamma correction level.....	24
(4.3) Changing detail (outline) gain.....	25
(4.4) Changing DTL B.FREQ (detail boost frequency).....	25
(4.5) Changing master pedestal	25
(5) MATRIX(Matrix color correction)	26
(5.1) Changing Matrix color correction ON/OFF	26
(5.2) Changing MATRIX setting	26
(6) OPTION	27
(6.1) Changing a type of output monitors	27
(7) Returning to factory settings	27
8. BEFORE MAKING SERVICE CALL.....	28
9. SPECIFICATIONS	28
10. EXTERNAL APPEARANCE DIAGRAM.....	29

Warranty

1. CAUTIONS ON USE AND INSTALLATION

- **Handling the unit.**

Do not drop, jolt, or vibrate, as this may result in damage to the unit. This may cause problems. Treat the camera cables carefully to prevent cable problems, such as breaks in the cable and loose connections.

- **Install the camera in a location free from noise.**

If the camera or the cables are located near power utility lines or a TV, etc. undesirable noise may appear on the screen. In such a case, try to change the location of the camera or the cable wiring.

- **Operating ambient temperature and humidity.**

Do not use the camera in places where temperature and humidity exceed the specifications. Picture quality will deteriorate and internal parts may be damaged.

Be particularly careful when using in places exposed to direct sunlight. When shooting in hot places, depending on the conditions of the object and the camera (for example when the gain is increased), noise in the form of vertical strips or white dots may occur.

This is not a malfunction.

- **When not using the camera for extended periods of time.**

Switch the control unit off and disconnect the power supply.

- **Avoid using or storing the camera in the following places:**

Places filled with highly flammable gas.

Places near gasoline, benzene, or paint thinner.

Places subject to strong vibration.

Places containing chemicals (such as pesticides), rubber or vinyl products for extended periods of time.

- **Do not shoot intense light.**

When intense light enters, vertical stripes or transverse band may appear on the screen. This is not a malfunction. Ghosts may occur when there is an intense light near the object. In this case, change the shooting angle.

- **Moire**

A moire pattern is an interference pattern generated when two repetitive line patterns overlap. This is not a malfunction. Eliminating the repetitive line patterns, or aligning the two patterns, will eliminate the moire.

- **Handling of the protection cap.**

Keep the protection cap away from children as they may pose a choking hazard. The protection cap protects the image sensing plane when the lens is removed from the camera head, do not discard.

- **When cleaning the camera.**

Unplug the power source before cleaning. Clean with a soft dry cloth only. Do not use any chemicals or chemically treated cloths. Chemicals may damage coatings, printing or the paint work. When cleaning the lens, use lens cleaning paper.

- **Installation without a tripod.**

Before installing the camera, make sure that the location can withstand the total weight of the camera.

If this is not the case, reinforce the area to prevent the unit from dropping, which may result in damage to the unit or personal injury.

- **This camera is for indoor use only.**

2. COMPONENTS

(1) Camera	1
(2) Accessories	
(a) Instruction manual	1

3. NAMES AND FUNCTIONS

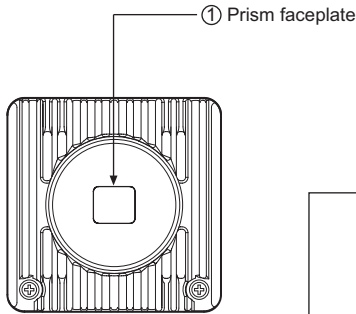

[Front]

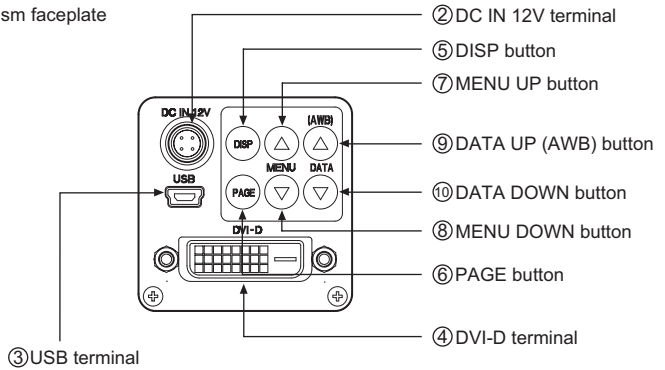

[Rear]

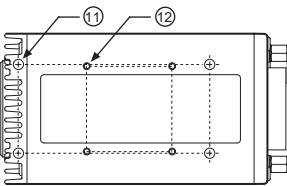

Rear

[Bottom]

- | | |
|------------------------|--|
| ① Prism faceplate | The protection cap is attached on the lens mount portion. After removing the cap, mount the lens. Be careful not to scratch or touch the optical area. |
| ② DC IN 12V terminal | Accepts a DC power input (12V). |
| ③ USB Terminal | USB terminal. It is used when displaying video on a computer or recording video into a computer. |
| ④ DVI-D terminal | Outputs DVI-D to connect to a DVI monitor. |
| ⑤ DISP button | Used to display or clear the Menu (OSD). |
| ⑥ PAGE button | Used when switching to the menu and when selecting the menus. |
| ⑦ MENU UP button | Select the function to be confirmed or changed on the menu. |
| ⑧ MENU DOWN button | Select the function to be confirmed or changed on the menu. |
| ⑨ DATA UP (AWB) button | Changes the value of the function selected by the MENU (UP/DOWN) button. (Also used when using AWB.) |
| ⑩ DATA DOWN button | Changes the value of the function selected by the MENU (UP/DOWN) button. |
| ⑪ Mounting holes M3 | Used to attach the camera to a mount. When using a tripod, attach the mounting bracket (option) to these holes. |
| ⑫ Mounting holes M2 | Used to attach the camera to a mount. |

4. CONNECTION

4. 1 Standard Connection

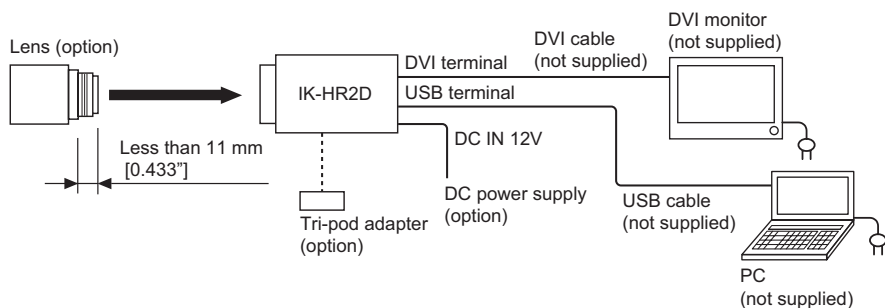

4. 2 Cautions on Connection

- When connecting the camera cables, be sure to turn off the CMOS color camera and any other equipment connected to it.
- For DC power supply connecting to DC IN 12V terminal, use UL listed and/or CSA approved ungrounded type AC adaptor with the specifications described below.

Power supply voltage	: 12V DC \pm 10%
Current rating	: More than 830mA
Ripple voltage	: Less than 50mV (p-p)
Connector	: HR10A-7P-4S by HIROSE electronics Co. Ltd
	Pins 1, 2 : 12V
	Pins 3, 4 : GND

- We suggest using a mega pixel C mount lens. When using other lenses, the best camera performance may not be obtained.
(For example, low resolution may occur, focus may be lost through the range of a zoom lens, and flare, ghost may occur.)

Furthermore, in order to avoid damaging the mounting portion of the camera head, use a lens which has projection dimension from the mounting base of less than 0.433" (11mm.)

- * **This camera's video output signal will not automatically sense the resolution of the DVI monitor it is connected to. If a monitor does not support this camera's output mode, it will not display anything. Please be sure to switch the output mode of this camera in accordance with the monitor resolution. Refer to the item "5.3 Switching video signal output" for the operation.**

* About DVI standard

There are three types of DVI connectors: DVI-I (Integrated : digital and analog), DVI-D (digital only), and DVI-A (analog only).

Please use a DVI-D cable (commercially available) to connect this camera.

- * To display video with USB, use a computer which installs a USB 2.0 terminal and USB Video Class Driver.

*** Recommended PC:**

- O S:** Windows® XP SP2 - SP3
Windows Vista®
Windows® 7
- C P U:** Intel® Pentium® compatible (x86 or x64) CPU
1 GHz or more.

Memory: 512 MB or more

- * Please be aware that this camera will depend on the computer, environment, or cables and unless these are compatible, the camera may not operate correctly.
- * Please be aware that the PC will be required to run DirectX® as the API (Application Program Interface) to interface with the video from the camera. For the correct use and application of this software, please refer to the API user manual.
- * This camera may not operate correctly when used concurrently with other USB devices.
- * This camera does not operate with bus power of the computer. Please use DC power.
- * Please connect this camera directly to a USB socket of a computer. It may not operate correctly through a USB hub.
- * This camera does not support USB 1.1 or previous standards.

4. 3 Connection on Rear Panel

This camera has the following connection terminals on its rear panel:

- DC IN 12V terminal
- USB terminal
- DVI-D terminal

Please connect the appropriate cables for the connections required.

Rear panel view

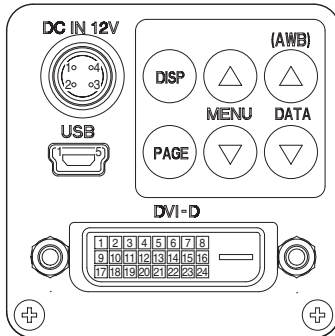

DC IN 12V terminal

1	+12V
2	+12V
3	GND
4	GND

USB terminal

1	V bus
2	D-
3	D+
4	ID
5	GND

DVI-D terminal

1	Data2-	9	Data1-	17	Data0-
2	Data2+	10	Data1+	18	Data0+
3	Data2 Shield (GND)	11	Data1 Shield (GND)	19	Data0 Shield (GND)
4	NC	12	NC	20	NC
5	NC	13	NC	21	NC
6	NC	14	+5V	22	Clock Shield (GND)
7	NC	15	GND	23	Clock+
8	NC	16	Hot Plug Detect	24	Clock-

- * Please use cables which support mini USB (type B) to connect the camera with the USB terminal. Connect a cable correctly, or it may be damaged.

5. OPERATION

- ① Refer to the item "4. CONNECTION", and connect the equipment correctly.
- ② Turn on the connected equipment and the camera.
- ③ Aim the lens at the object, adjust the lens iris adjustment, focus adjustment, etc.
- ④ Refer to the item "5.1 White Balance", make the adjustment.
- ⑤ Please see "5.2 Gain", "5.3 Switching video signal output" and "7. MODE SETTING BY THE ON SCREEN DISPLAY" to carry out necessary operations.
- ⑥ Please see "5.4 Displaying video with USB" to carry out an operation when using the USB output.

5. 1 White Balance

For white balance adjustment of this unit, ATW (Automatic Tracking White balance), AWB (Automatic White Balance) and MANUAL (Manual white balance) adjustments are provided. Refer to the item "7.3 (3) WHT BAL (White Balance)", select the desired mode.

	ATW (Automatic Tracking White Balance)	AWB (Automatic White Balance)	MANUAL (Manual White Balance)
Outline	The camera measures the object color temperature and adjusts the white balance automatically.	Adjust white balance by displaying the white object inside the area set by AWB menu and pressing the [DATA UP] button.	Adjust the white balance manually using the WHT BAL menu while shooting the white object.
Features	Tracks variations of color temperature and adjusts white balance automatically.	Measurement accuracy is higher than ATW. This mode is effective when shooting under less variations of color temperature.	Artificial white balance setting. The manual adjustment is most effective under shooting conditions with no color temperature variation.
Notes	If illumination is low, white balance may not be corrected.		Adjustment is performed by confirming with a monitor.

(1) AWB(Automatic White Balance)

- ① Set the MODE to AWB on the WHT BAL menu.
Perform the C.TEMP (color temperature conversion) setting, if necessary.
(Refer to the item "7.3 (3) WHT BAL (White Balance)".)
 - 3200K: Appropriate for indoor shooting.
 - 5600K: Appropriate for outdoor shooting.
- ② If the color bar pattern is displayed on the screen or if the index menu/menu is displayed, press the [DISP] button to disable the color bar pattern or the character display on the menu.
- ③ Shoot a known white object entirely in the area set by the AWB menu (refer to the item "7.3 (3) (3.1) (d) Confirming the contents of the zone area selected by AWB") and press [DATA UP] button for approx. 1 second.
- ④ The character AWB blinks on the screen when the AWB starts.
- ⑤ The character AWB stops blinking when the AWB finishes, and the result is displayed for approx. 1 second.

Display	Meaning
AWB OK	Automatic white balance adjustment finished correctly.
AWB NG LEVEL LOW	Automatic white balance adjustment cannot be performed because the video level is too low. Adjust the video level by increasing the illumination or opening the lens iris.
AWB NG LEVEL HIGH	Automatic white balance adjustment cannot be performed because the video level is too high. Adjust the video level by decreasing the illumination or closing the lens iris.
AWB NG C. TEMP LOW	Automatic white balance adjustment cannot be performed because the color temperature is too low. If the C.TEMP is set to 5600K, set to 3200K. If the message appears with the C.TEMP set to 3200K, change the illumination or use a color temperature conversion filter.
AWB NG C. TEMP HIGH	Automatic white balance adjustment cannot be performed because the color temperature is too high. If the C.TEMP is set to 3200K, set to 5600K. If the message appears with the C.TEMP set to 5600K, change the illumination or use the color temperature conversion filter.
AWB NG	Automatic white balance adjustment cannot be performed for other reasons. Such as no white area is included in an object, etc.

(2) MANUAL(Manual white balance)

- ① Set the MODE to MANUAL on the WHT BAL menu.
(Refer to the item "7.3 (3) WHT BAL (White Balance)".)
- ② Shoot a known white object, set the white balance by adjusting the levels of R GAIN and B GAIN on the menu, confirming with a monitor or a vector scope.
(Refer to the item "7.3 (3) (3.3) Changing gain in MANUAL mode".)

5. 2 Gain

When the image is dark even if the lens iris is open, change the gain (video gain) to get the desired video level. For gain adjustment of the unit, MANUAL (Manual), OFF (0 dB) modes are provided. Select the mode on the GAIN menu. (Refer to the item "7.3 (2) GAIN (Video gain)".)

(1) MANUAL(Manual gain)

Gain adjustment is performed on the GAIN menu. The adjustment range is from 0 to 18dB in 1dB steps. (Refer to the item "7.3 (2) (2.1) Changing gain in MANUAL mode".)

(2) OFF

Gain is fixed at 0 dB.

Note:

White, red, green, or blue dots may occur when the gain is increased. This is not a malfunction, just certain characteristics of the CMOS sensor becoming more visible.

5. 3 Switching video signal output

By turning on the power while the control buttons on the rear panel are pressed, the video signal output of the DVI-D terminal can be switched. When the video signal output is switched, a mode is displayed on the screen for about 5 seconds.
e.g. "1080p 59.94"

Mode	Resolution	How to operate
1080/59.94p	1920×1080/59.94Hz (progressive)	Turn on power while pressing [DISP]
1080/50p	1920×1080/50Hz (progressive)	Turn on power while pressing [PAGE]
1080/59.94i	1920×1080/59.94Hz (interlace)	Turn on power while pressing [MENU UP]
1080/50i	1920×1080/50Hz (interlace)	Turn on power while pressing [MENU DOWN]
720/59.94p	1280×720/59.94Hz (progressive)	Turn on power while pressing [DATA UP]
720/50p	1280×720/50Hz (progressive)	Turn on power while pressing [DATA DOWN]

Note:

Resolution specified by the computer to which a USB cable is connected has priority while displaying/recording video from the USB terminal.

Please disconnect the USB cable before switching the video signal output.

5. 4 Display video with USB

- Connect a USB terminal of the camera and a USB terminal of the computer with a USB cable.
- Turn on the power of both the camera and the computer.
- Run the viewer software.
- * Please use a cable supporting mini-USB (B type) for the USB terminal of the camera.
- * To display video captured by the camera, viewer software supporting USB Video Class is required separately.
- * In case of Windows® XP SP2 or SP3, the built-in viewer software can be used.
The procedure for using the viewer software is described below:
 - Click Start Menu → My Computer
 - Double click USB Video Device icon, and the video will be displayed.

The following can be controlled by USB from a computer. Some viewer software may not support this function.

Resolution :

- ①1920×1080 YUY2 Approximately 5fps
- ②1280×720 YUY2 Approximately 10fps

Exposure time :

AUTO ON: The electronic shutter is set to AUTO mode.

AUTO OFF: The electronic shutter is set to MANUAL mode.

In Manual mode the exposure time can be set between OFF to 1/4000s.

White balance :

AUTO ON: The White balance is set to ATW mode.

AUTO OFF: The White balance is set to AWB mode.

The color temperature can be set to 3200K or 5600K in the AWB mode.

Note:

- When displaying video with USB, resolution is changed to the one specified by the computer (viewer), regardless of the resolution set in “5.3 Switching video signal output”.
- When the resolution is set by the computer (viewer), the DVI output mode appears in the upper right of screen for about 5 seconds.
e.g. “1080p 59.94”

Note that the displayed mode is not a USB output mode.

- When the computer (viewer) sets resolution to 1920 × 1080 while you are using the camera in the 720p mode, the DVI output mode will also be changed to the 1080p mode.
- The exposure time and white balance set during video display with USB will be stored. Next time, at the beginning of video display with USB, the new setting will be reflected regardless of the current camera setting.

6. ITEMS CONTROLLED BY THE ON SCREEN DISPLAY

Item		Available selections	Preset value (Factory setting)*1				
			File A	File B	File C	File D	File E
Electronic shutter	MODE	AUTO, MANUAL, SS	MANUAL	MANUAL	AUTO	AUTO	AUTO
	AUTO level	-100 — 0 — 100	0	0	0	0	0
	AUTO peak : average	00 : 10 — 05 : 05 — 10 : 00	05 : 05	05 : 05	05 : 05	05 : 05	00 : 10
	AUTO response speed	1 — 10 — 20	10	10	10	20	20
	AUTO area	PRESET A, PRESET B, PRESET C, PRESET D, PRESET E	PRESET A	PRESET A	PRESET A	PRESET A	PRESET A
	MANUAL speed	OFF, 1/100s, 1/125s, 1/250s, 1/500s, 1/1000s, 1/2000s, 1/4000s	OFF*2	OFF*2	OFF*2	OFF*2	OFF*2
	Syncro. scan	15/1125H — 1123/1125H (when 1080 is set) 10/750H — 748/750H (when 720 is set)	1123/1125H 748/750H	1123/1125H 748/750H	1123/1125H 748/750H	1123/1125H 748/750H	1123/1125H 748/750H
Gain	MODE	MANUAL, OFF	OFF*3	OFF*3	OFF*3	OFF*3	OFF*3
	MANUAL gain	0dB — 18dB	0dB	0dB	0dB	0dB	0dB
White balance	MODE	AWB, ATW, MANUAL	AWB	AWB	ATW	AWB	AWB
	Color temperature	3200K, 5600K	3200K	5600K	3200K	5600K	5600K
	AWB R PAINT	-10 — 0 — 10	0	0	0	0	0
	AWB B PAINT	-10 — 0 — 10	0	0	0	0	0
	AWB area	PRESET A, PRESET B, PRESET C, PRESET D, PRESET E	PRESET A	PRESET A	PRESET A	PRESET A	PRESET A
	ATW R PAINT	-10 — 0 — 10	0	0	0	0	0
	ATW B PAINT	-10 — 0 — 10	0	0	0	0	0
	MANUAL R GAIN	-100 — 0 — 100	0	0	0	0	0
	MANUAL B GAIN	-100 — 0 — 100	0	0	0	0	0
Process	Gamma correction	ON, OFF	ON	ON	ON	ON	ON
	Gamma correction level	-10 — 0 — 10	0	0	0	0	0
	Detail gain	-7 — 0 — 7	0	0	0	0	0
	Detail boost frequency	HIGH, NORMAL, LOW	HIGH	HIGH	HIGH	HIGH	HIGH
	Master pedestal	-128 — 0 — 127	0	0	0	0	0
Matrix color correction	Color correction ON/OFF	ON, OFF	ON	ON	ON	ON	ON
	R hue	-15 — 0 — 15	0	0	0	0	-2
	R gain	-15 — 0 — 15	0	0	0	0	15
	G hue	-15 — 0 — 15	0	0	0	0	0
	G gain	-15 — 0 — 15	0	0	0	0	0
	B hue	-15 — 0 — 15	0	0	0	0	10
	B gain	-15 — 0 — 15	0	0	0	0	10
	Ye hue	-15 — 0 — 15	0	0	0	0	0
	Ye gain	-15 — 0 — 15	0	0	0	0	15
	Cy hue	-15 — 0 — 15	0	0	0	0	0
	Cy gain	-15 — 0 — 15	0	0	0	0	15
	Mg hue	-15 — 0 — 15	0	0	0	0	-15
Mg gain	-15 — 0 — 15	0	0	0	0	15	
Option	Monitor	PC, TV	PC				

*1: Scene file A is selected as the factory setting.

*2: 1/60s (when 59.94 Hz is set) or 1/50s (when 50 Hz is set)

*3: Gain 0 dB

7. MODE SETTING BY THE ON SCREEN DISPLAY

Various settings can be controlled on the unit by using the on screen menu displayed on the monitor. The contents once set are memorized in the scene files (A, B, C, D, E) selected, so if the power turns off, it is unnecessary to set the values again when using the unit next time. When the setting is performed, select the menu of the item to be set.

Note:

The characters displayed while operating the on screen display menu (OSD) or auto white balance (AWB) are output from the camera control unit as an image superimposed on the picture. Once the picture is recorded, you cannot separate characters from the picture nor remove only the displayed characters from the recorded signal. Be careful of operating the OSD and AWB while taking picture.

7. 1 Using the Menus

When the unit is powered on, the normal screen showing only the video signal appears. Change the output to each screen (video signal output, color bar screen, index menu, and menus) by using the [DISP], [PAGE], [MENU UP], [MENU DOWN], [DATA UP], and [DATA DOWN] buttons.

- * A menu is selected when pushing the [PAGE] button after moving the "→" on the screen by the [MENU UP], [MENU DOWN] button while the Index menu is displayed.
 - * When Index menu is displayed, the DVI output mode appears in the upper right of the screen.
- Note: The displayed mode is not a USB output mode.

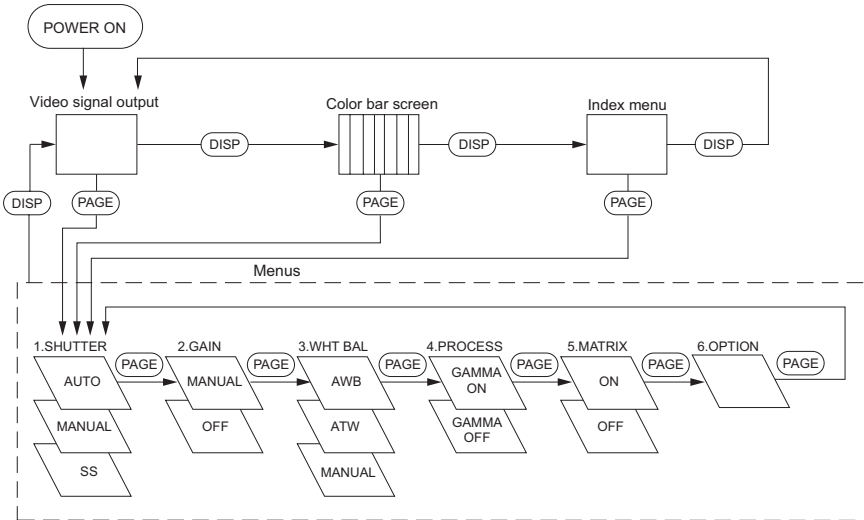

7. 2 Scene File

Five scene files (A, B, C, D, E) are available as user memories for this unit. These are chosen depending on shooting conditions. By pressing [DATA UP], [DATA DOWN] buttons while [DISP] button is pressed and the index menu is displayed, the camera operation is changed immediately from the currently selected scene file to the next. By pressing [DATA UP], [DATA DOWN] buttons while the Index menu is displayed, the camera operation is changed immediately from the currently selected scene file to the next.

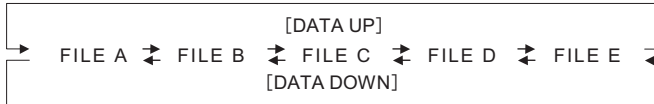

Note:

Scene file does not contain the data of set "OPTION."

(Refer to the item "7.3 Menus" (6) "OPTION" for the "OPTION" setting.)

7. 3 Menus

- Select the menu to change the setting by referring to the item "7.1 Using the Menus".
- When the [MENU UP], [MENU DOWN] buttons are pressed, the "→" on the screen moves up and down. Move the "→" to the item whose setting you wish to change.

(1) SHUTTER (Electronic shutter)

The electronic shutter has three modes; AUTO, MANUAL, SS(Synchro Scan).

Press the "Page" button to enter the Shutter Page. Use the "Data Up/Down" buttons to select the Shutter Mode.

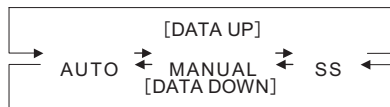

- AUTO : The exposure time is controlled automatically to obtain the video level set.
- MANUAL : It is possible to select the exposure time from eight speed settings; OFF (1/60s:59.94Hz setting, 1/50s:50Hz setting), 1/100s, 1/125s, 1/250s, 1/500s, 1/1000s, 1/2000s, 1/4000s.
- SS : Shutter speed can be set by the horizontal scanning time (1H) unit.

Note:

- **When setting a rapid shutter speed, sensitivity degrades according to the speed. When a discharging light such as fluorescent lamp, etc. is used for the illumination, the flicker may be large.**
- **When an object is moving rapidly, the monitor may display the image distorted and/or blurred. Also, under the discharging light such as fluorescent lamp, etc., horizontal striped light and dark patterns may be displayed on the screen. Depending on the timing of flash and/or strobe firing, the contrast may be displayed on the screen. This is not a malfunction but just a certain character of the rolling shutter system.**
- **When the shutter speed setting is high, the hue may change depending on shooting conditions or objects.**

(1. 1) Changing the setting in AUTO mode

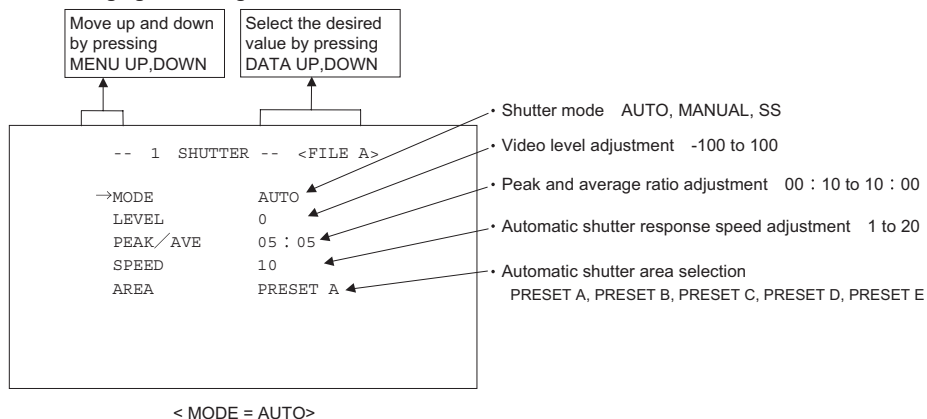

(a) Changing the video level in the automatic shutter mode

- Move the "→" to LEVEL by pressing [MENU UP], [MENU DOWN] buttons.
- Select the video level by pressing [DATA UP], [DATA DOWN] buttons.

The value increases by pressing [DATA UP]

-100 ↔ 0 ↔ 100

The value decreases by pressing [DATA DOWN]

(b) Changing the automatic shutter detection (ratio between peak and average value)

- Move the "→" to PEAK/AVE by pressing [MENU UP], [MENU DOWN] buttons.
- Select the ratio between peak and average value by pressing [DATA UP], [DATA DOWN] buttons.

(Peak:Average)

The peak value increases by pressing [DATA UP]

00:10 ↔ 05:05 ↔ 10:00

The peak value decreases by pressing [DATA DOWN]

(c) Changing the automatic shutter response speed

- Move the "→" to SPEED by pressing [MENU UP], [MENU DOWN] buttons.
- Select the response speed by pressing [DATA UP], [DATA DOWN] buttons.

The response speed becomes faster by pressing [DATA UP]

1 ↔ 10 ↔ 20

The response speed becomes slower by pressing [DATA DOWN]

(d) Changing the automatic shutter zone area

- ① Move the "→" to AREA by pressing [MENU UP], [MENU DOWN] buttons.
- ② Select the measurement light area by pressing [DATA UP], [DATA DOWN] buttons.

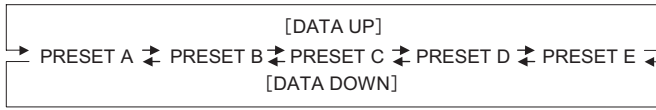

The available picture area is divided into 64 rectangles. The user can choose one of 5 presets. The shaded rectangles represents the area/pattern where the sampling is taken from.

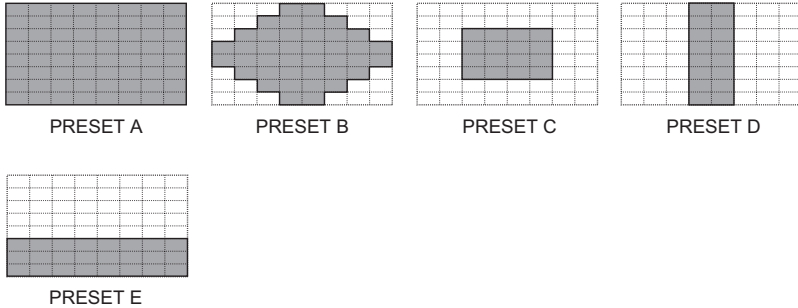

(1. 2) Changing the setting in MANUAL mode

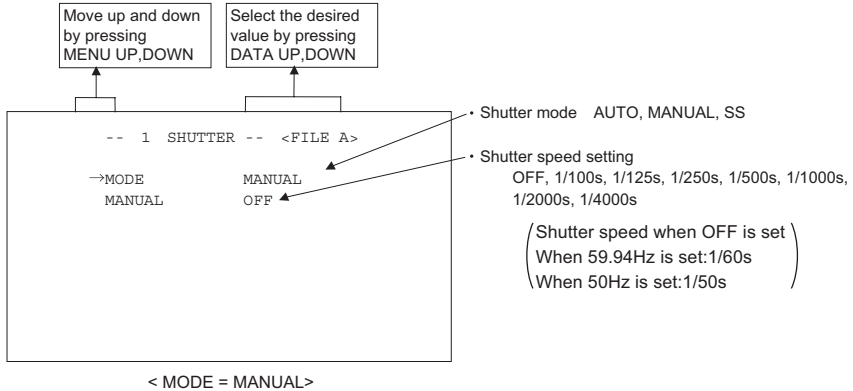

(a) Changing the shutter speed

- ① Move the “→” to MANU by pressing [MENU UP], [MENU DOWN] buttons.
- ② Select the shutter speed by pressing [DATA UP], [DATA DOWN] buttons.

[DATA UP]
 OFF ↔ 1/100s ↔ 1/125s ↔ 1/250s ↔ 1/500s ↔ 1/1000s ↔ 1/2000s ↔ 1/4000s
 [DATA DOWN]

Note:

The shutter speed can be set in every effective scanning line (1080/720).

The figures of shutter speed in the menu screen are approximate. The accurate shutter speed is calculated using the following mathematical formula.

$$\begin{aligned} \text{Shutter speed (s)} &= 1/67433 \text{ (Hz)} \times n \quad (n : 15 \text{ to } 1123 \text{ (integral number)}) \text{ (when 1080/59.94p and 1080/59.94i are set)} \\ &= 1/56250 \text{ (Hz)} \times n \quad (n : 15 \text{ to } 1123 \text{ (integral number)}) \text{ (when 1080/50p and 1080/50i are set)} \\ &= 1/44955 \text{ (Hz)} \times n \quad (n : 10 \text{ to } 748 \text{ (integral number)}) \text{ (when 720/59.94p is set)} \\ &= 1/37500 \text{ (Hz)} \times n \quad (n : 10 \text{ to } 748 \text{ (integral number)}) \text{ (when 720/50p is set)} \end{aligned}$$

(1. 3) Changing the setting in SS (Synchro Scan) mode

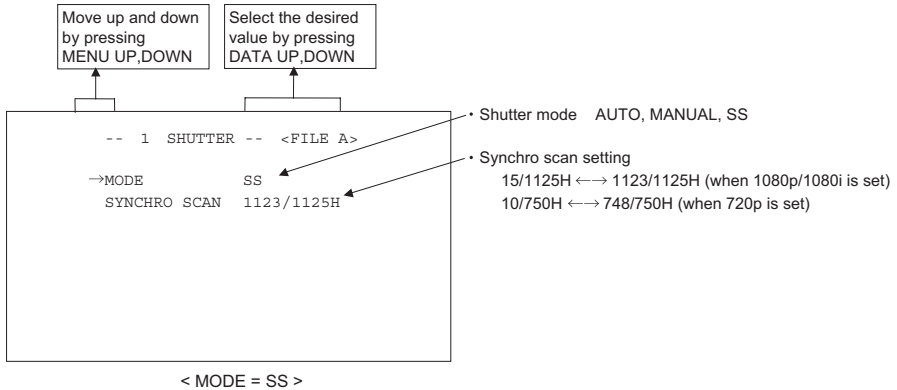

(a) Changing the shutter speed setting

- ① Move the “→” to SYNCHRO SCAN by pressing [MENU UP], [MENU DOWN] buttons.
- ② Select the shutter speed by pressing [DATA UP], [DATA DOWN] buttons.

[DATA UP]
 15/1125H ↔ 1123/1125H (when 1080p/1080i is set)
 10/750H ↔ 748/750H (when 720p is set)
 [DATA DOWN]

Note:

The shutter speed can be set in every effective scanning line (1080/720).

(2) GAIN (Video gain)

GAIN has two modes; MANUAL, OFF.

Move the “→” to MODE, press the [DATA UP], [DATA DOWN], and select one of the two modes : MANUAL, OFF. In the OFF mode, gain is fixed to 0dB.

(2. 1) Changing gain in MANUAL mode

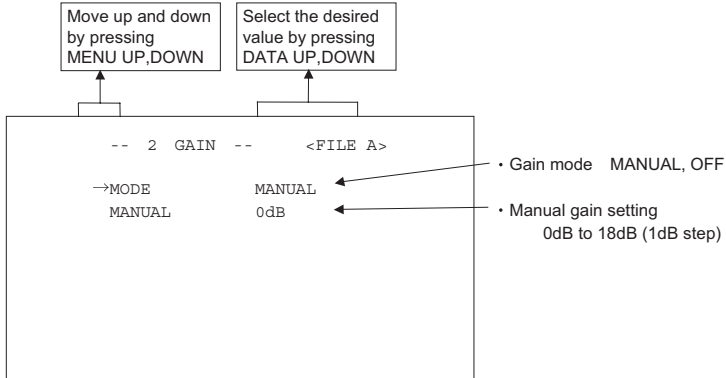

- ① Move the “→” to MANUAL by pressing [MENU UP], [MENU DOWN] buttons.
- ② Select the desired value of manual gain by pressing [DATA UP], [DATA DOWN] buttons.

[DATA UP]
0dB ↔ 18dB
[DATA DOWN]

(3) WHT BAL(White Balance)

The WHT BAL has three modes; AWB, ATW, MANUAL.

Move the “→” to MODE, press the [DATA UP], [DATA DOWN], and select one of the three modes : AWB, ATW, MANUAL.

(3. 1) Changing the setting in AWB(Automatic White Balance) mode

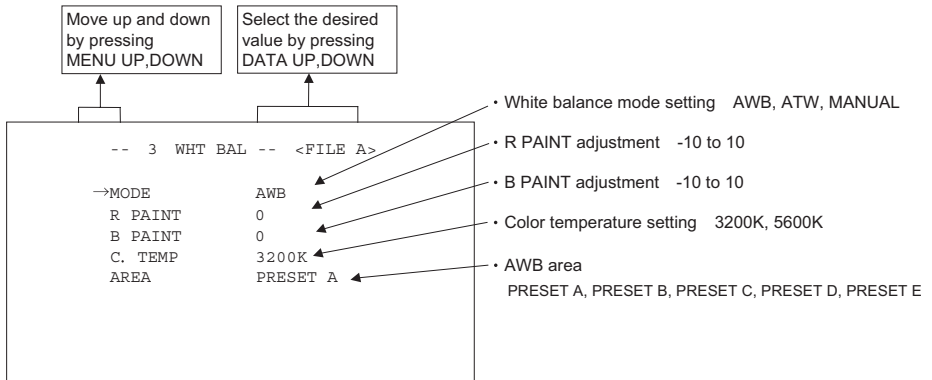

(a) Changing R PAINT

- ① Move the “→” to R PAINT by pressing [MENU UP], [MENU DOWN] buttons.
- ② Select the desired value of red paint by pressing [DATA UP], [DATA DOWN] buttons.

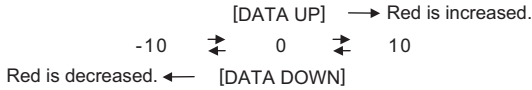

(b) Changing B PAINT

- ① Move the “→” to B PAINT by pressing [MENU UP], [MENU DOWN] buttons.
- ② Select the desired value of blue paint by pressing [DATA UP], [DATA DOWN] buttons.

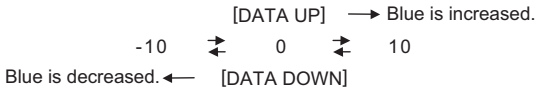

(c) Changing color temperature setting

- ① Move the “→” to C.TEMP by pressing [MENU UP], [MENU DOWN] buttons.
- ② Select either 3200K or 5600K by pressing [DATA UP], [DATA DOWN] buttons.

(d) Confirming the contents of the zone area selected by AWB

- ① Move the “→” to AREA DISP by pressing [MENU UP], [MENU DOWN] buttons.
- ② Select the desired area by pressing [DATA UP], [DATA DOWN] buttons.

The available picture area is divided into 64 rectangles. The user can choose one of 5 presets. The shaded rectangles represents the area/pattern where the sampling is taken from.

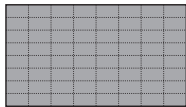

PRESET A

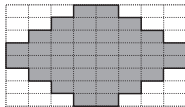

PRESET B

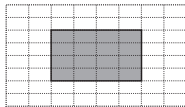

PRESET C

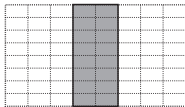

PRESET D

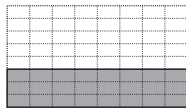

PRESET E

(3. 2) Changing the setting in ATW(Automatic Tracking White balance) mode

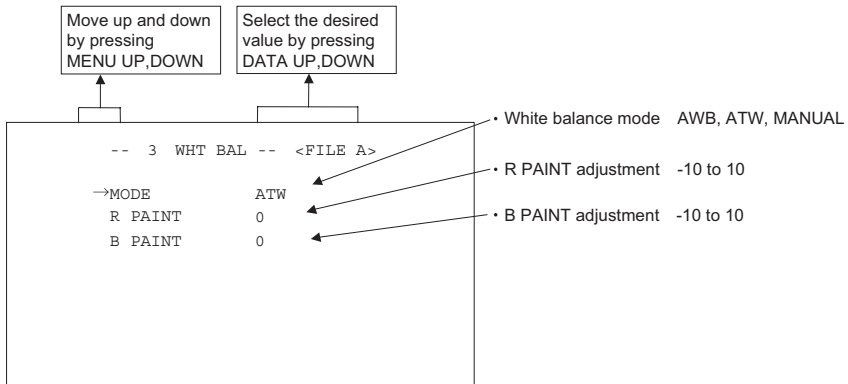

(a) Changing R PAINT

- ① Move the "→" to R PAINT by pressing [MENU UP], [MENU DOWN] buttons.
- ② Select the desired value of red paint by pressing [DATA UP], [DATA DOWN] buttons.

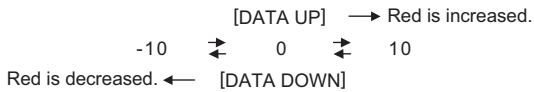

(b) Changing B PAINT

- ① Move the "→" to B PAINT by pressing [MENU UP], [MENU DOWN] buttons.
- ② Select the desired value of blue paint by pressing [DATA UP], [DATA DOWN] buttons.

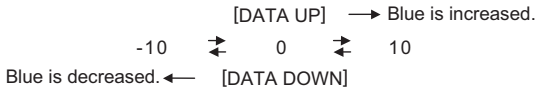

(3. 3) Changing gain in MANUAL mode

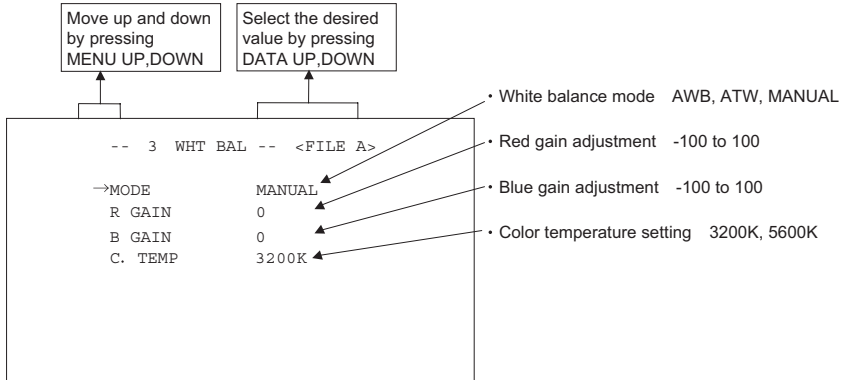

(a) Changing the red gain

- ① Move the "→" to R GAIN by pressing [MENU UP], [MENU DOWN] buttons.
- ② Select the desired value of red gain by pressing [DATA UP], [DATA DOWN] buttons.

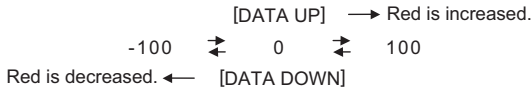

(b) Changing the blue gain

- ① Move the "→" to B GAIN by pressing [MENU UP], [MENU DOWN] buttons.
- ② Select the desired value of blue gain by pressing [DATA UP], [DATA DOWN] buttons.

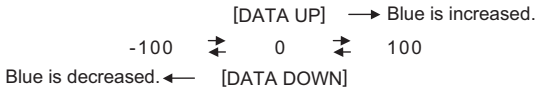

(c) Changing color temperature setting

- ① Move the "→" to C.TEMP by pressing [MENU UP], [MENU DOWN] buttons.
- ② Select either 3200K or 5600K by pressing [DATA UP], [DATA DOWN] buttons.

(4) PROCESS

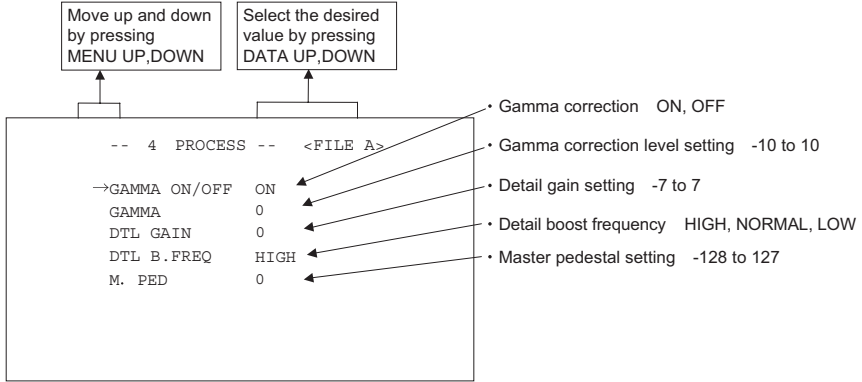

(4. 1) Changing gamma correction ON/OFF

- ① Move the "→" to GAMMA ON/OFF by pressing [MENU UP], [MENU DOWN] buttons.
- ② Select either ON or OFF by pressing [DATA UP], [DATA DOWN] buttons.

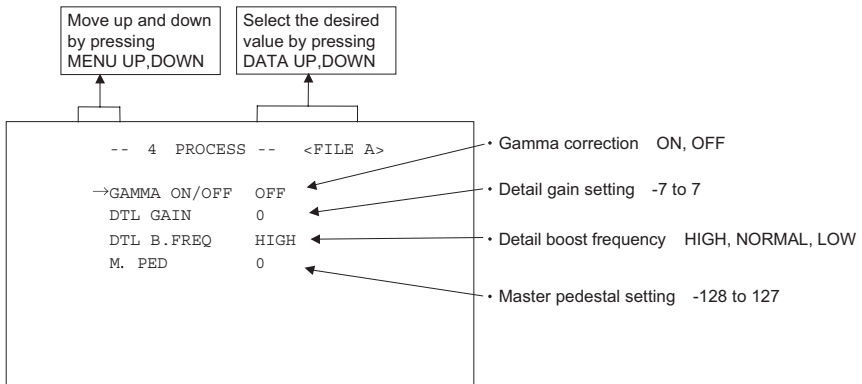

Menu when GAMMA OFF is selected.

(4. 2) Changing gamma correction level

- ① Move the "→" to GAMMA by pressing [MENU UP], [MENU DOWN] buttons.
- ② Select the desired value of gamma correction level by pressing [DATA UP], [DATA DOWN] buttons.

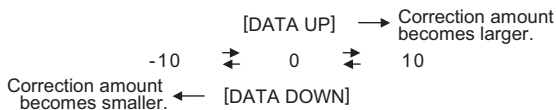

* When OFF is selected in GAMMA ON/OFF selection line, the gamma correction level cannot be changed.

(4. 3) Changing detail (outline) gain

- ① Move the "→" to DTL GAIN by pressing [MENU UP], [MENU DOWN] buttons.
- ② Select the desired value of the detail gain by pressing [DATA UP], [DATA DOWN] buttons.

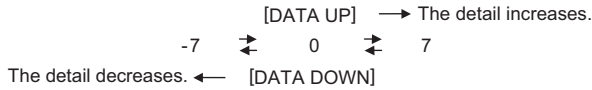

(4. 4) Changing DTL B.FREQ (detail boost frequency)

This setting adjusts the thickness of the image outline.

- ① Move the "→" to DTL B.FREQ by pressing [MENU UP], [MENU DOWN] buttons.
- ② Select the detail boost frequency by pressing [DATA UP], [DATA DOWN] buttons.

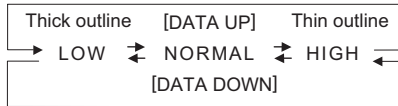

(4. 5) Changing master pedestal

- ① Move the "→" to M. PED by pressing [MENU UP], [MENU DOWN] buttons.
- ② Select the desired value of the master pedestal by pressing [DATA UP], [DATA DOWN] buttons.

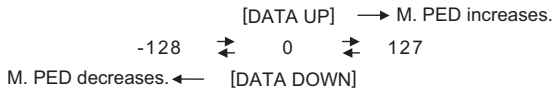

(5) MATRIX(Matrix color correction)

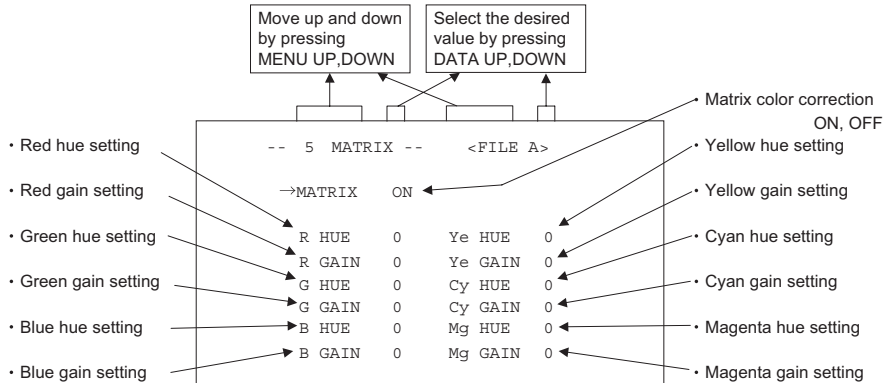

(5. 1) Changing Matrix color correction ON/OFF

- ① Move the "→" to MATRIX by pressing [MENU UP], [MENU DOWN] buttons.
- ② Select either ON or OFF by pressing [DATA UP], [DATA DOWN] buttons.

(5. 2) Changing MATRIX setting

- ① Move the "→" to the desired item by pressing [MENU UP], [MENU DOWN] buttons.
- ② Select the desired value of color by pressing [DATA UP], [DATA DOWN] buttons.

[DATA UP]
 -15 ↔ 0 ↔ 15
 [DATA DOWN]

*** When matrix color correction is set to OFF, the color cannot be adjusted.**

(6) OPTION

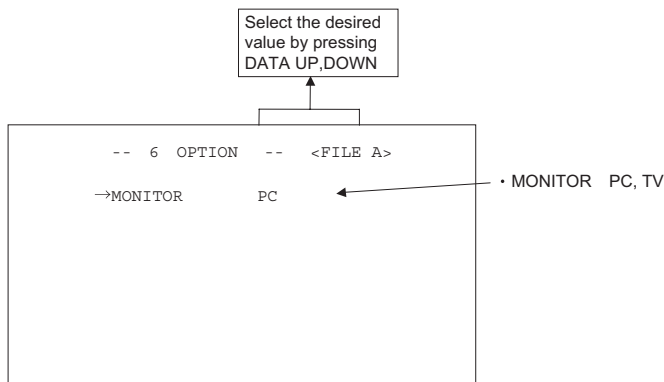

(6. 1) Changing a type of output monitors

Select either PC or TV by pressing [DATA UP], [DATA DOWN] buttons.

- PC: When using PC as an output monitor.
- TV: When using TV as an output monitor.

Note:

Select PC or TV depending on the DVI monitor you use. If TV is selected, the brightness on the monitor will be increased. This setting has nothing to do with the USB video output.

(7) Returning to factory settings

The current setting can be returned to the factory default status (preset status).

- (1) If the color bar pattern or characters are displayed on the screen, press the [DISP] button to disable the color bar pattern and character display.
- (2) Press [MENU DOWN] and [DATA DOWN] buttons simultaneously for approx. 1 second.
- (3) The preset operation starts. When the preset operation finishes, the character PRESET OK is displayed for approx. 1 second.

*** Only one scene file at a time can be returned to the factory default status. Follow the instruction as above for every scene file when all scene files are required to be returned to the factory default status/settings.**

8. BEFORE MAKING SERVICE CALL

Symptom	Items to be checked
No picture	<ul style="list-style-type: none"> · Is power supplied correctly? · Is the lens iris adjusted correctly? · Are the camera and video cables connected correctly? · Is the shutter mode set correctly? · Does the video output from the camera match with the input signals from the monitor?
Unstable picture Noise problem	<ul style="list-style-type: none"> · Is the cable connector loose? · Are the other cables connected correctly?
Poor color	<ul style="list-style-type: none"> · Is the monitor adjusted correctly? · Is the white balance of the camera adjusted correctly? (in modes other than automatic tracking) · Is the matrix color correction set correctly? · Is the illumination sufficient?

9. SPECIFICATIONS

Image sensor	1/3 inch color CMOS sensor (Rolling shutter)
Output pixels	Horizontal : 1920, Vertical : 1080
Signal system	1080/59.94p, 1080/50p, 1080/59.94i, 1080/50i, 720/59.94p, 720/50p
Scan frequency	Horizontal : 67.43 kHz, Vertical : 59.94 Hz Horizontal : 56.25 kHz, Vertical : 50 Hz Horizontal : 33.72 kHz, Vertical : 59.94 Hz Horizontal : 28.13 kHz, Vertical : 50 Hz Horizontal : 44.96 kHz, Vertical : 59.94 Hz Horizontal : 37.50 kHz, Vertical : 50 Hz
Sensitivity	F 4 standard (2000 lx, 3000K)
Minimum illumination	8 lx standard (50 IRE, F1.4, gain +18 dB, gamma setting ON (setting value 0), 3000 K)
Output signal	DVI (Digital RGB) DVI-D terminal USB Video Class 1.1 mini-USB terminal (in conformity with USB 2.0)
Sync system	Internal
White balance	ATW (Automatic tracking white balance), AWB (Automatic white balance), MANUAL (Manual)
Gain	MANUAL (Manual), OFF (0 dB)
Scene file	A, B, C, D, E
Lens mount	C mount
Power supply	12V DC ± 10%
Power consumption	Approx. 4.1 W
Weight	Approx. 148 g (0.326 lbs)
External dimension	44(W) × 44(H) × 78(D) mm (1.73"(W) × 1.73"(H) × 3.07"(D))
Operating temperature	0 °C to 40 °C (32° F to 104° F)
Operating humidity	Less than 90% (non condensing)

● Design and specifications are subject to change without notice.

10. EXTERNAL APPEARANCE DIAGRAM

Unit : mm [inch]

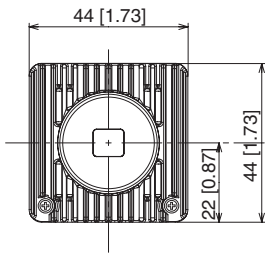
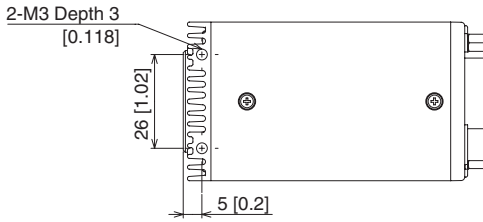

[Front]

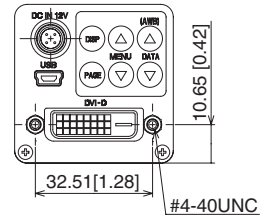
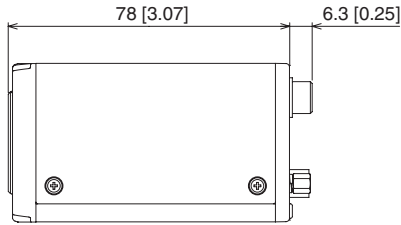

[Rear]

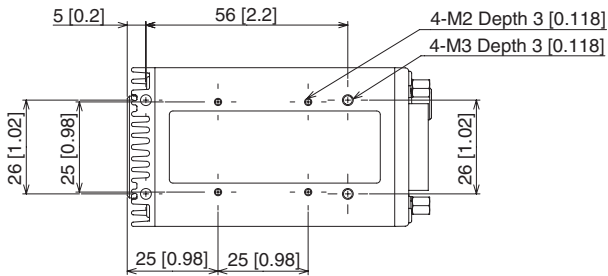

Limited Warranty –TOSHIBA CMOS Color Camera

The Imaging Systems Division of Toshiba America Information Systems, Inc. ("ISD") makes the following limited warranties with regard to this CMOS Color Camera ("Product"). These limited warranties extend to the Original End-User ("You[r]").

One (1) Year Limited Warranty of Labor and Parts

ISD warrants that this Product will perform in accordance with specifications for a period of one (1) year from the date of purchase by the Original End-User. During this one (1) year period, ISD will repair or replace the Product, if it does not perform as warranted. In order to take advantage of this Limited Warranty, You must: (a) deliver the Product to an ISD Authorized Service Provider ("ASP"); and (b) pay all transportation and insurance charges for shipment of the Product to the ASP. ISD reserves the right to substitute factory refurbished parts in place of those in need of repair.

Instruction Manual (Owner's Manual):

You should read the Instruction Manual (Owner's Manual) thoroughly before operating this Product. Before seeking warranty service, you should check the troubleshooting guide in the Instruction Manual (Owner's Manual) and follow the instructions to correct the problem.

Your Responsibilities

This Limited Warranty is subject to the following conditions:

1. You must provide the bill of sale or proof of purchase at the time that warranty service is required.
2. You must notify an ASP within thirty (30) days after You discover that the Product does not perform in accordance with specifications during the Limited Warranty period.
3. All warranty servicing of this product must be made by an ISD Authorized Service Provider.
4. You must pack the Product in its original carton using the original packing material, then insert the original carton containing the Product into another carton with additional packing material before shipping the Product to an ASP.

DISCLAIMERS:

ALL OTHER EXPRESS OR IMPLIED WARRANTIES ON THIS PRODUCT, INCLUDING THE IMPLIED WARRANTIES OF MERCHANTABILITY AND FITNESS FOR A PARTICULAR PURPOSE, ARE HEREBY DISCLAIMED. SOME STATES DO NOT ALLOW THE EXCLUSION OF IMPLIED WARRANTIES OR LIMITATIONS ON HOW LONG AN IMPLIED WARRANTY LASTS, SO THE ABOVE LIMITATIONS MAY NOT APPLY TO YOU.

IF THIS PRODUCT IS NOT IN GOOD WORKING ORDER AS WARRANTED ABOVE, YOUR SOLE AND EXCLUSIVE REMEDY SHALL BE THE REPAIR OR REPLACEMENT OF THE PRODUCT. IN NO EVENT WILL ISD OR ITS PARENT COMPANY OR ANY ASP BE LIABLE TO YOU OR ANY THIRD PARTY FOR ANY DAMAGES IN EXCESS OF THE PURCHASE PRICE OF THE PRODUCT. THIS LIMITATION APPLIES TO DAMAGES OF ANY KIND, INCLUDING ANY DIRECT OR INDIRECT DAMAGES, LOST PROFITS, LOST SAVINGS OR OTHER SPECIAL, INCIDENTAL, EXEMPLARY OR CONSEQUENTIAL DAMAGES, WHETHER FOR BREACH OF CONTRACT, TORT OR OTHERWISE, OR WHETHER ARISING OUT OF THE USE OF OR INABILITY TO USE SUCH PRODUCT, EVEN IF TAIS, ITS PARENT COMPANY, OR AN ASP HAS BEEN ADVISED OF THE POSSIBILITY OF SUCH DAMAGES OR OF ANY CLAIM BY ANY OTHER PARTY. SOME STATES DO NOT ALLOW THE EXCLUSION OR LIMITATION OF INCIDENTAL OR CONSEQUENTIAL DAMAGES FOR SOME PRODUCTS, SO THE ABOVE LIMITATIONS OR EXCLUSIONS MAY NOT APPLY TO YOU.

THIS WARRANTY GIVES YOU SPECIFIC LEGAL RIGHTS, AND YOU MAY ALSO HAVE OTHER RIGHTS WHICH MAY VARY FROM STATE TO STATE.

THIS LIMITED WARRANTY SHALL BE VOID IF THE PRODUCT OR PARTS HAVE BEEN SUBJECTED TO MISUSE, ABUSE, ACCIDENT, IMPROPER INSTALLATION, IMPROPER MAINTENANCE, OR USE IN VIOLATION OF ISD'S WRITTEN INSTRUCTIONS, OR WHERE THE PRODUCT HAS BEEN ALTERED OR MODIFIED WITHOUT ISD'S PRIOR AUTHORIZATION, OR UPON THE REMOVAL OR ALTERATION OF ISD'S FACTORY SERIAL NUMBER. LABOR SERVICE CHARGES FOR PRODUCT INSTALLATION, SET UP AND ADJUSTMENT OF CONTROLS ARE NOT COVERED BY THIS LIMITED WARRANTY.

How to Obtain Warranty Service – Step-By-Step Procedures:

To obtain warranty service, You should:

1. Contact an ASP for warranty service within thirty (30) days after the Product fails to comply with specifications.
2. Arrange for shipment of the Product to an ASP.
3. Securely pack the Product as described above, insure the carton, and include a letter explaining the problem and a copy of the bill of sale or proof of purchase.
4. Prepay all transportation and insurance costs.

Questions? If you have any questions, please check ISD's Web Site or send an e-mail as follows:

Web Site: <http://www.toshiba.com/taisisd/indmed>

E-mail: mefasupport@tais.toshiba.com

No person, agent, distributor, dealer, authorized service provider, or company is authorized to change, modify, or extend the terms of this Limited Warranty in any manner whatsoever. The time within which an action must be commenced to enforce any obligation of ISD arising under this Limited Warranty or under any statute, or law of the United States or any state thereof, is hereby limited to one (1) year from the date You discover or should have discovered the problem. This limitation does not apply to implied warranties arising under state law. Some states do not permit limitation of the time within which You may bring an action beyond the limits provided by state law, so the above provision may not apply to You. This Limited Warranty gives You specific legal rights and You may also have other rights which vary from state to state.

TOSHIBA AMERICA INFORMATION SYSTEMS, INC.

Imaging Systems Division
9740 Irvine Boulevard, Irvine, CA 92618-1697

Copyright © 2010 Toshiba America, Inc. All rights reserved.

TOSHIBA